

## Product Datasheet - WSL 5050 Series - Single Doors

The Wrightstyle 5050 series range of glazing systems provides an unlimited number of fenestration options. Utilising a wide range of high quality steel and stainless steel profile shapes, it provides countless possibilities.

Multiple configurations of doors, screens and windows can be produced from Wrightstyle's vast range of profiles; an integral part of Wrightstyle's total glazing system solutions.

Profiles are produced from cold rolled pre-galvanised strip, manufactured to strict production tolerances from 2mm steel.

Modern manufacturing processes allow us to produce steel glazing systems, which combine the inherent strength and durability of steel, with the aesthetic qualities normally associated with aluminium systems. The following pages provide a brief overview of the capabilities of the systems.

- Competitively priced
- Multiple fenestration options
- High quality pre-senzimir galvanising
- Internal & external surface protection
- 2mm wall thickness
- Tested to 3 hours fire rating
- Multiple hardware options
- Multiple tape or gasket glazing options
- Can be supplied in bar length, semi-prepared kit form, or fully fabricated

### WSL 5050 Series - Door Configuration (colours shown for clarity)

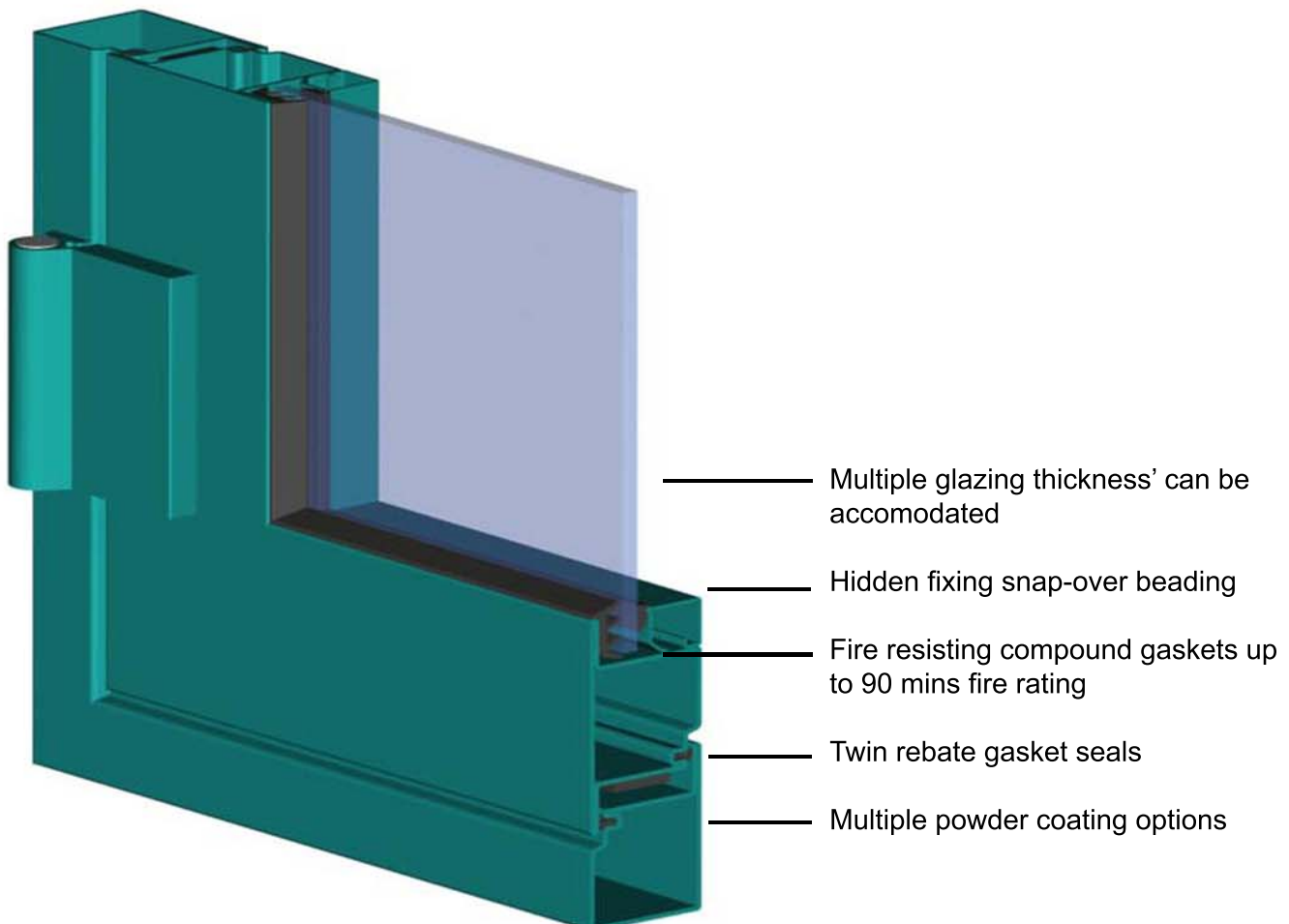

## Product Datasheet - WSL 5050 Series - Single Doors

RHR - Open Out

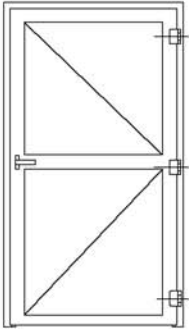

LHR - Open Out

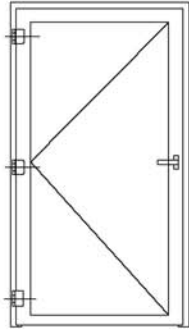

LH - Open In

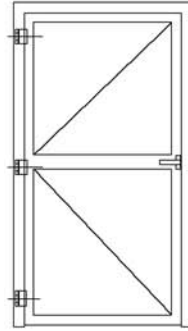

RH - Open In

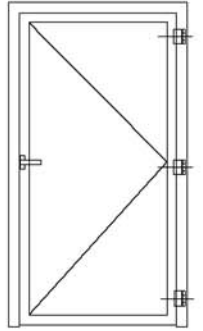

### WSL 5050 series door permissible dimensions 30 mins integrity only

Type:

Maximum Door Height

Maximum Door Width

Fire Rating

WSL 5050 Series door unlatched

2100mm clear passage

900mm clear passage

30 Mins integrity only

WSL 5050 Series door single point latch

2500mm clear passage

1200mm clear passage

30 Mins integrity only

WSL 5050 Series door two point latch

2615mm clear passage

1315mm clear passage

30 Mins integrity only

Directions:

Plot your required door size on the chart below. Current test data allows for any clear passage size within the red, blue & green areas.

If the door size falls completely within the blue area then the door may be installed unlatched.

If the door size falls partly within the red area then the door must have a minimum of a single-point latch.

If the door size falls partly within the green area then the door must have a minimum of a two-point latch.

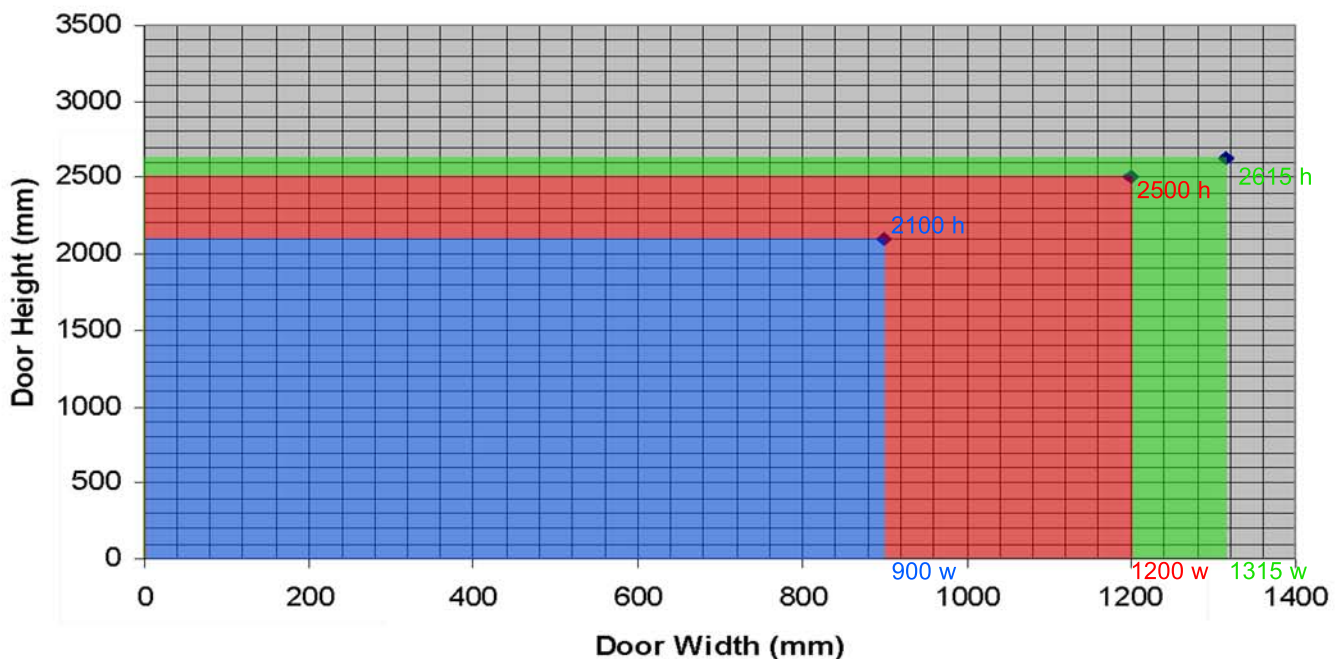

Note: Additional conditions may apply. Please check test data

## Product Datasheet - WSL 5050 Series - Single Doors

### WSL 5050 series door permissible dimensions 60 mins integrity only

Type:	Maximum Door Height	Maximum Door Width	Fire Rating
WSL 5050 Series door single point latch	2300mm clear passage	1100mm clear passage	60 Mins integrity only
WSL 5050 Series door two point latch	2550mm clear passage	1200mm clear passage	60 Mins integrity only

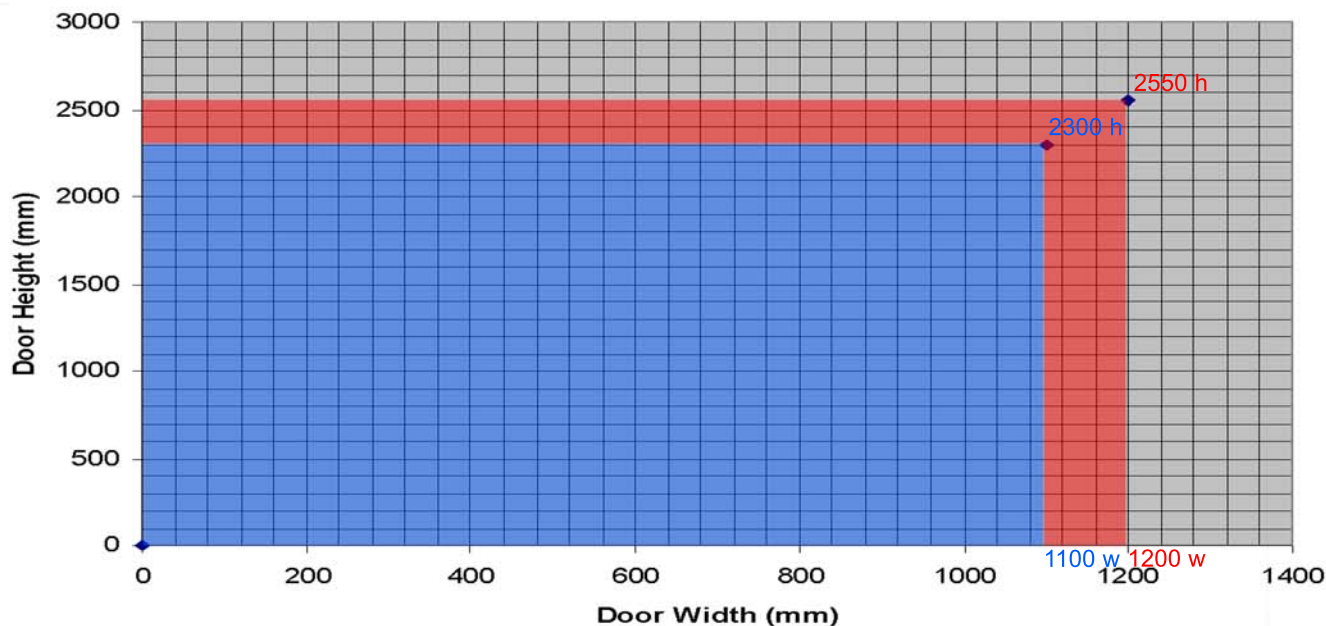

### WSL 5050 series door permissible dimensions 90,120 & 180 mins integrity only

Type:	Maximum Door Height	Maximum Door Width	Fire Rating
WSL 5050 Series door three point latch	2100mm clear passage	1100mm clear passage	90 Mins integrity only
WSL 5050 Series door three point latch	2100mm clear passage	1000mm clear passage	120 Mins integrity only
WSL 5050 Series door three point latch	2100mm clear passage	950mm clear passage	180 Mins integrity only

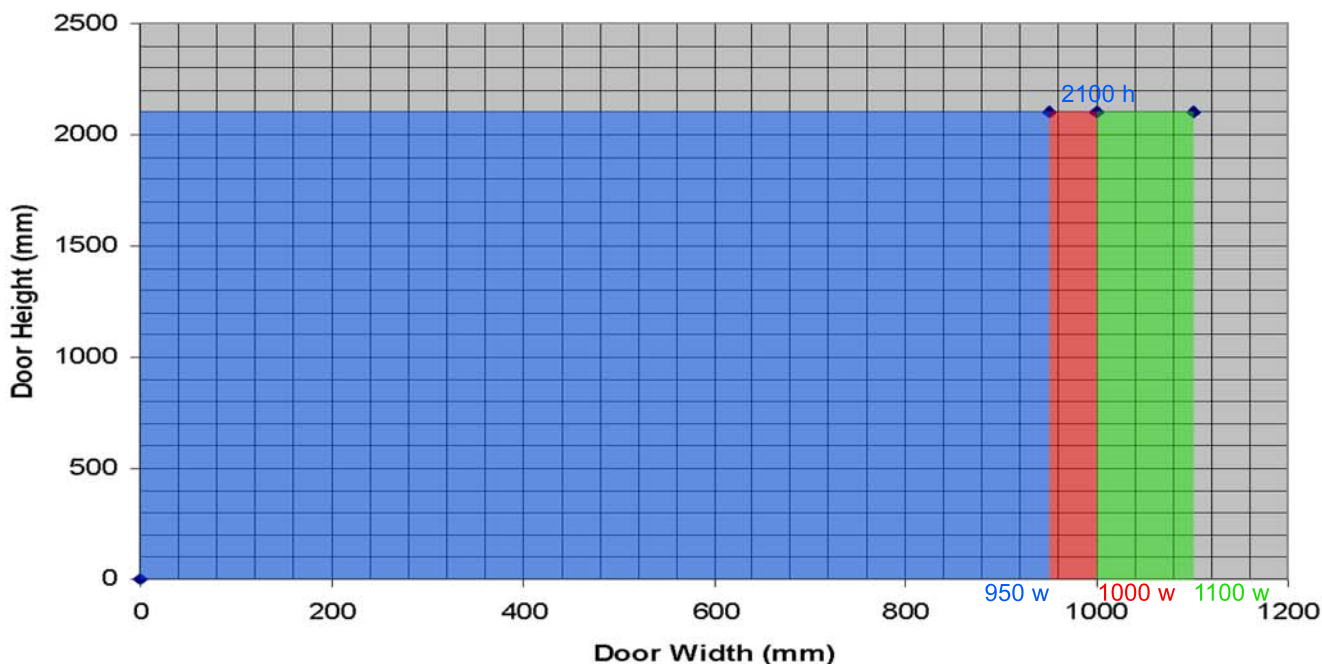

Note: Additional conditions may apply. Please check test data